

Features

Regulated Converters

- 4:1 Wide Input Voltage Range
- 1.6kVDC Isolation
- UL, EN50155 Certified
- Efficiency to 88%
- Protected Outputs
- High Input Voltage Range (110VDC)



RP08-AW

8 Watt
DIP24/SMD
Single & Dual
Output



Description

The RP08-AW series wide range input DC/DC converters are certified to UL 60950-1 and cUL 60950-1. This makes them ideal for all telecom and industrial applications where approved safety standards are required. The 24V and 110VDC input versions have been especially designed for railway applications. The DIP24 package is available in both pinned and SMD case styles and meets military standards for thermal shock and vibration tolerance.

Selection Guide

Part Number	Input Voltage Range (VDC)	Output Voltage (VDC)	Output Current (mA)	Input ⁽¹⁾ Current (mA)	Efficiency ⁽¹⁾ typ. (%)	Max. Capacitive Load ⁽²⁾ (µF)
RP08-243.3SAW ⁽³⁾	9-36	3.3	2400	388	85	1330
RP08-2405SAW ⁽³⁾	9-36	5	1600	383	87	1330
RP08-2412SAW ⁽³⁾	9-36	12	666	387	86	288
RP08-2415SAW ⁽³⁾	9-36	15	533	387	86	200
RP08-483.3SAW ⁽³⁾	18-75	3.3	2400	194	85	1330
RP08-4805SAW ⁽³⁾	18-75	5	1600	192	87	1330
RP08-4812SAW ⁽³⁾	18-75	12	666	191	87	288
RP08-4815SAW ⁽³⁾	18-75	15	533	189	88	200
RP08-1103.3SAW ⁽³⁾	43-160	3.3	2400	86	84	1330
RP08-11005SAW ⁽³⁾	43-160	5	1600	86	85	1330
RP08-11012SAW ⁽³⁾	43-160	12	666	84	86	288
RP08-11015SAW ⁽³⁾	43-160	15	533	85	86	200
RP08-2405DAW ⁽³⁾	9-36	±5	±800	397	84	±900
RP08-2412DAW ⁽³⁾	9-36	±12	±333	387	86	±133
RP08-2415DAW ⁽³⁾	9-36	±15	±267	388	86	±90
RP08-4805DAW ⁽³⁾	18-75	±5	±800	198	84	±900
RP08-4812DAW ⁽³⁾	18-75	±12	±333	191	87	±133
RP08-4815DAW ⁽³⁾	18-75	±15	±267	192	87	±90
RP08-11005DAW ⁽³⁾	43-160	±5	±800	89	82	±900
RP08-11012DAW ⁽³⁾	43-160	±12	±333	85	85	±133
RP08-11015DAW ⁽³⁾	43-160	±15	±267	86	85	±90

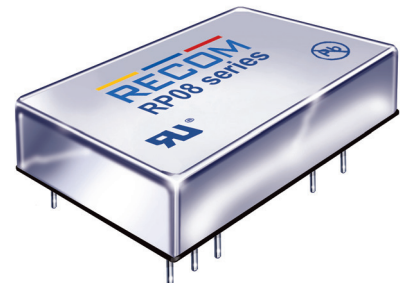
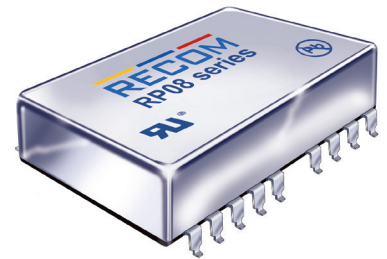

Notes:

- Note1: Maximum value at nominal input voltage and full load
 Note2: Test by minimum Vin and constant resistor load.



Model Numbering

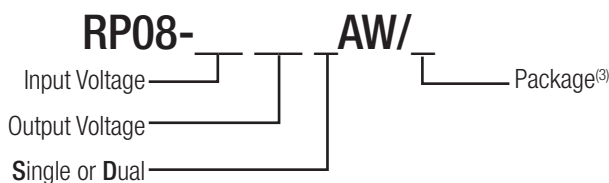

Ordering Examples

- RP08-4805AW/SMD = 48V Input, 5V Output, SMD Package
 RP08-2405AW = 24V Input, 5V Output, DIP24 Package

Notes:

- Note3: No suffix for standard package (DIP24), add suffix "SMD" for SMD package

UL60950-1 Certified
EN50155 Certified

Specifications measured at Ta = 25°C, nominal input voltage, full load otherwise noted

BASIC CHARACTERISTICS					
Parameter	Condition		Min.	Typ.	Max.
Input Voltage Range	nom. Vin = 24V nom. Vin = 48V nom. Vin = 110V		9VDVC 18VDC 43VDC	24VDC 48VDC 110VDC	36VDC 75VDC 160VDC
Under Voltage Lockout (UVLO)	Vin= 24V	DC-DC ON DC-DC OFF		8VDC	9VDC
	Vin= 48V	DC-DC ON DC-DC OFF		16VDC	18VDC
	Vin=110V	DC-DC ON DC-DC OFF		40VDC	43VDC
Input Filter					Pi-Type
Input reflected Ripple Current	nominal Vin and full load			20mA _{p-p}	
Input Surge Voltage	Vin = 24V, 100ms max. Vin = 48V, 100ms max. Vin = 110V, 100ms max.				50VDC 100VDC 170VDC
Start-up time	Power up Remote ON/OFF			450ms 5ms	
Operating Frequency Range			270kHz	300kHz	330kHz
Minimum Load			0%		
Ripple and Noise	20MHz bandwidth	Vin = 24V Vin = 48V Vin = 110V		50mV _{p-p} 50mV _{p-p} 75mV _{p-p}	
Remote ON/OFF ⁽⁴⁾	Positive Logic	DC-DC ON DC-DC OFF	Open or 3.0 < Vr < 12VDC Short or 0 < Vr < 1.2VDC		
Input current of Remote pin (CTRL)	DC-DC OFF			2.5mA	
	DC-DC ON		-0.5mA		+0.5mA

Notes:

Note4: The ON/OFF control pin voltage is referenced to -Vin pin.

RP08-2405SAW

Efficiency vs. Output Current

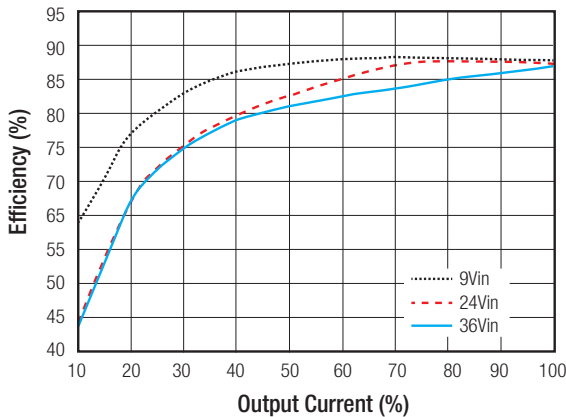

Efficiency vs. Input Voltage

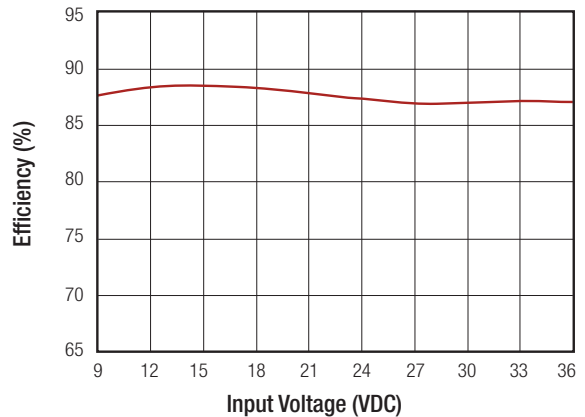

continued on next page

Specifications measured at Ta = 25°C, nominal input voltage, full load otherwise noted

RP08-4805SAW

Efficiency vs. Output Current

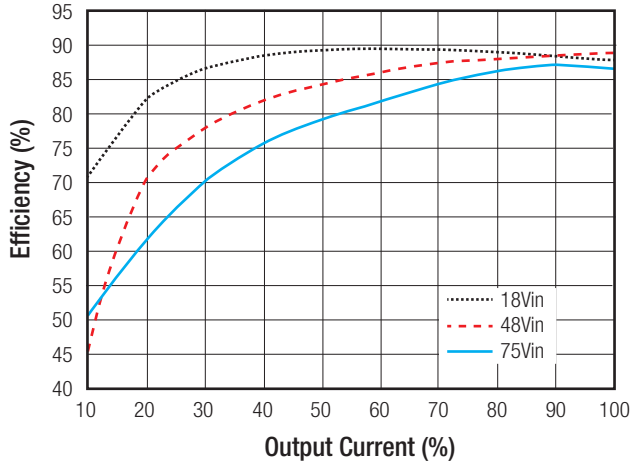

Efficiency vs. Input Voltage

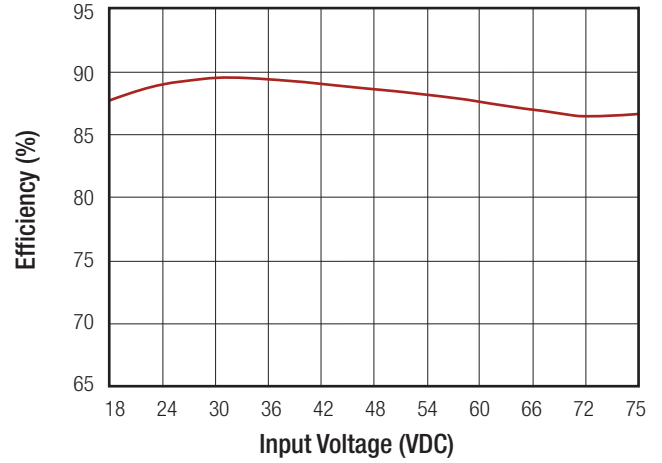

RP08-11005SAW

Efficiency vs. Output Current

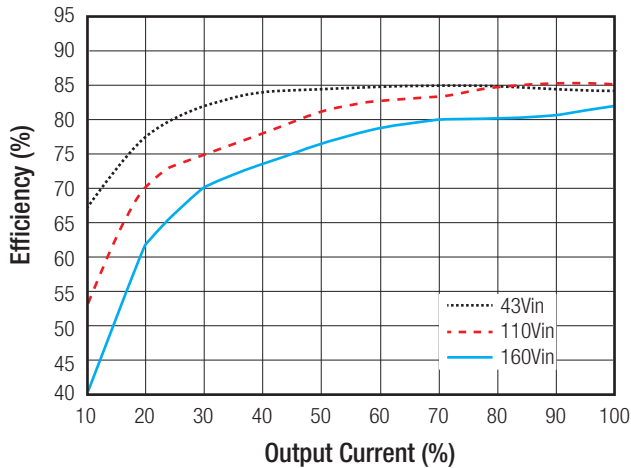

Efficiency vs. Input Voltage

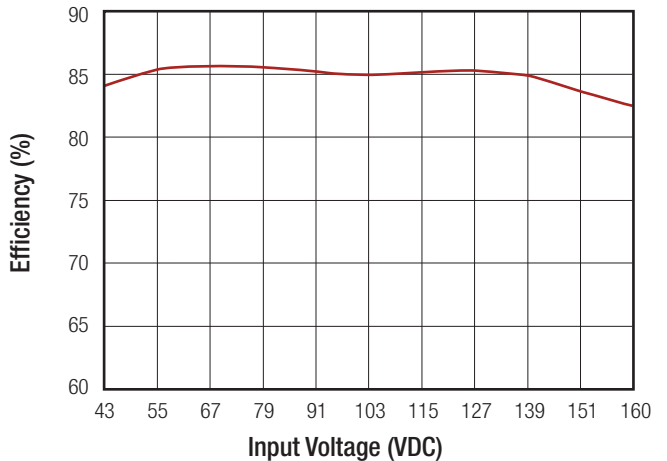

REGULATIONS

Parameter	Condition		Value
Output Voltage Accuracy			±1%
Line Voltage Regulation	low line to high line, full load		±0.2%
Load Voltage Regulation	no load to full load	DIP24 Single	±0.5%
		DIP24 Dual	±1%
	10% load to 90% load	SMD Single	±1%
		SMD Dual	±1%
Cross Regulation	asymmetrical 25% <-> 100% load		±5%
Transient Response recovery time	25% load step change		250µs typ.

Specifications measured at Ta = 25°C, nominal input voltage, full load otherwise noted

PROTECTIONS			
Parameter	Condition	Value	
Short Circuit Protection (SCP)		continuous, automatic recovery	
Over Voltage Protection (OVP)	Single Output	3.3Vout	3.9VDC typ.
		5Vout	6.2VDC typ.
		12Vout	15VDC typ.
		15Vout	18VDC typ.
Over Load Protection (OLP)	% of Iout rated	150% typ.	
Isolation Voltage	DIP24	I/P to O/P I/P (O/P) to case	1.6kVDC/1 minute 1.6kVDC/1 minute
	SMD	I/P to O/P I/P (O/P) to case	1.6kVDC/1 minute 1.0kVDC/1 minute
Isolation Resistance	500VDC	1GΩ min.	
Isolation Capacitance		1500pF max.	
Notes: Note5: This power module is not internally fused. An input line fuse must always be used.			

ENVIRONMENTAL		
Parameter	Condition	Value
Operating Temperature Range ⁽⁶⁾	without derating	-40°C to +85°C
	with derating	-40°C to +105°C
Maximum Case Temperature		+105°C
Temperature Coefficient		±0.02%/°C max.
Thermal Impedance	Natural convection (20LFM)	20°C/Watt
Operating Humidity	non-condensing	5% - 95% RH
Shock		MIL-STD-810F
Thermal Shock		MIL-STD-810F
Vibration		MIL-STD-810F
MTBF	MIL-HDBK-217F	2832 x 10 ³ hours
	Bellcore-TR-NWT-000332 ⁽⁷⁾	2350 x 10 ³ hours

Derating Graph⁽⁸⁾

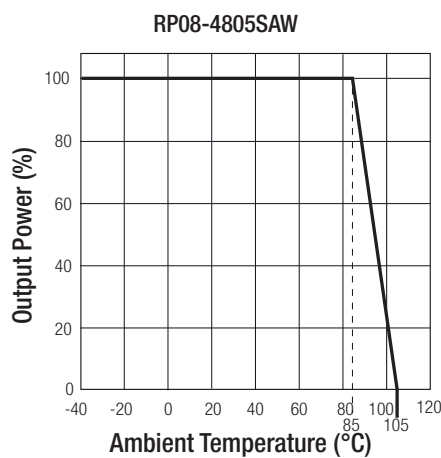

Notes:

- Note6: Converter can meet the railway T2 and TX temperature requirement
- Note7: BELLCORE TR-NWT-000332. Case I: 50% Stress, Temperature at 40°C (Ground Benign and controlled environment). MIL-HDBK-217F, Notice 2, Full Load, 25°C, Ground Benign.
- Note8: Derating graphs are valid only for the shown part numbers. If you need detailed derating-information about a part-number not shown here please contact our technical support service at techsupportAT@recom-power.com.

Specifications measured at $T_a = 25^\circ\text{C}$, nominal input voltage, full load otherwise noted

SAFETY AND CERTIFICATIONS

Certificate Type (Safety)	Report / File Number	Standard
UL General Safety	E196683 except 110VDC Input - UL Pending	UL60950-1 1st Ed.: 2003 C22.2 No. 60950 1st. Ed.: 2003
Railway	15A100704E-C	EN50155

EMC Compliance

EMC Compliance	Condition	Standard / Criterion
EMI Standard ⁽⁹⁾	with external filter	EN55022, EN55011, Class A or B
ESD	Air $\pm 8\text{kV}$ and Contact $\pm 6\text{kV}$	EN61000-4-2, Criteria A
Radiated Immunity	20 V/m	EN61000-4-3, Criteria A
Fast Transient ⁽¹⁰⁾	$\pm 2\text{kV}$	EN61000-4-4, Criteria A
Surge ⁽¹⁰⁾	$\pm 2\text{kV}$	EN61000-4-5, Criteria A
Conducted Immunity	10 Vr.m.s	EN61000-4-6, Criteria A

Notes:

Note9: The standard modules meet EMI Class A or Class B with external components, see filter suggestions below.

Note10: An external input filter capacitor is required if the module has to meet EN61000-4-4, EN61000-4-5.

Recom suggests Nippon chemi-con KY series 220 $\mu\text{F}/100\text{V}$ (24V and 48V) or 150 $\mu\text{F}/200\text{V}$ (110V).

EMI Filtering Class A

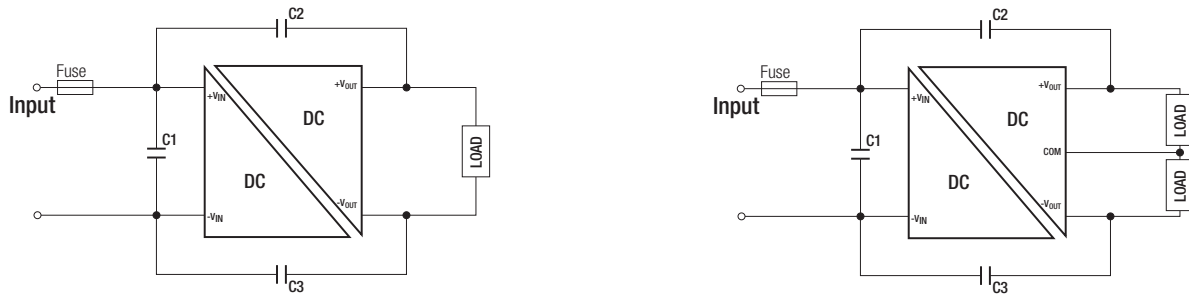

MODEL	C1	C2	C3/C4
RP08-24xxS_DW	1.0 $\mu\text{F}/50\text{V}$	N/A	1000pF/2kV
RP08-24xxS_DW/SMD	1210MLCC		1206 MLCC
RP08-48xxS_DW	0.47 $\mu\text{F}/100\text{V}$	N/A	1000pF/2kV
RP08-48xxS_DW/SMD	1810MLCC		1206 MLCC
RP08-110xxS_DW	1 $\mu\text{F}/250\text{V}$	1 $\mu\text{F}/250\text{V}$	1000pF/2kV
RP08-110xxS_DW/SMD	1812 MLCC	1812 MLCC	1206 MLCC

EMI Filtering Class B

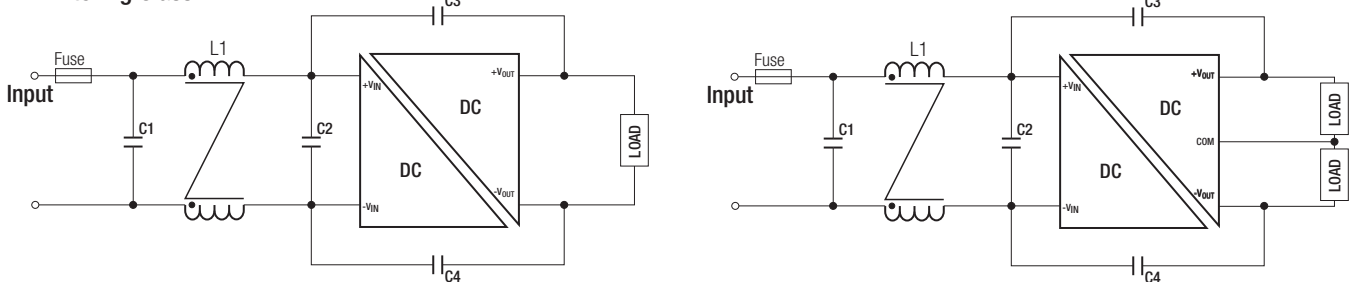

MODEL	C1	C2	C3/C4	C5	L1
RP08-24xxS_DW	4.7 $\mu\text{F}/50\text{V}$	N/A	1000pF/2kV	N/A	CMC: 325 μH ref.: WE 744290321 ref.: CMC-06
RP08-24xxS_DW/SMD	1812 MLCC		1206 MLCC		
RP08-48xxS_DW	1.5 $\mu\text{F}/100\text{V}$	1.5 $\mu\text{F}/100\text{V}$	1000pF/2kV	N/A	CMC: 325 μH ref.: WE 744290321 ref.: CMC-06
RP08-48xxS_DW/SMD	1812 MLCC	1812 MLCC	1206 MLCC		
RP08-110xxS_DW	1 $\mu\text{F}/250\text{V}$	N/A	1000pF/2kV	22 $\mu\text{F}/200\text{V}$ Al Cap. (lie down) Chemi-con KMF	CMC: 497 μH ref.: WE 7448013501
RP08-110xxS_DW/SMD	1812 MLCC		1206 MLCC		

Specifications measured at Ta = 25°C, nominal input voltage, full load otherwise noted

DIMENSIONS and PHYSICAL CHARACTERISTICS

Parameter	Type	Value
Material	Case	Nickel coated copper
	Base	Non-conductive black plastic
	Potting	Epoxy (UL94-V0)
Package Dimensions (LxWxH)	DIP	31.8 x 20.3 x 10.3mm
	SMD	32.0 x 21.3 x 10.9mm
Package Weight	DIP	18g
	SMD	20g

DIP24 Dimension Drawing (mm)

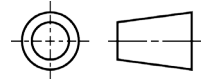
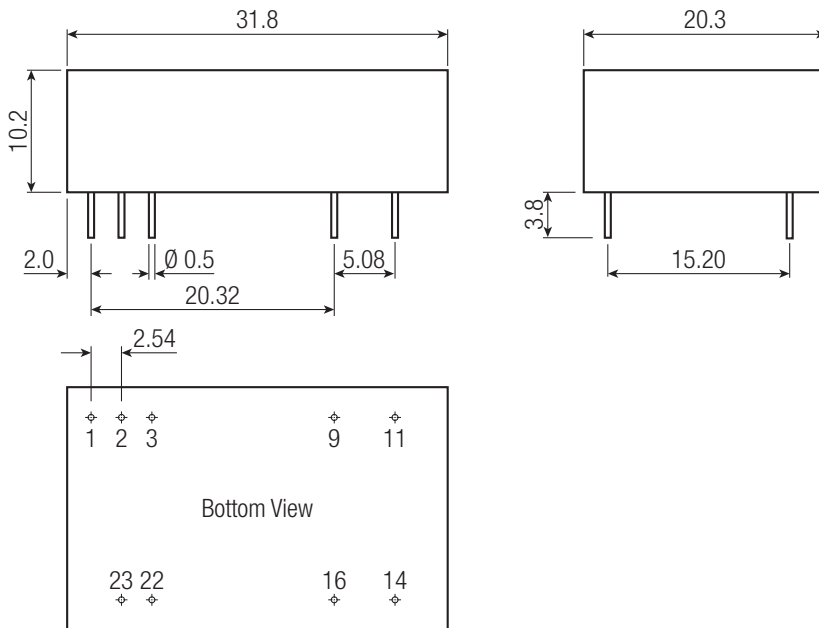

Pin Connections

Pin #	Single	Dual
1	Ctrl	Ctrl
2	-Vin	-Vin
3	-Vin	-Vin
9	NC	Com
11	NC	-Vout
14	+Vout	+Vout
16	-Vout	Com
22	+Vin	+Vin
23	+Vin	+Vin

NC = No Connection
 Pin Pitch Tolerance ±0.25mm
 Pin dimension tolerance ±0.1mm
 XX.X ± 0.5mm
 XX.XX ± 0.25mm

SMD Dimension Drawing (mm)

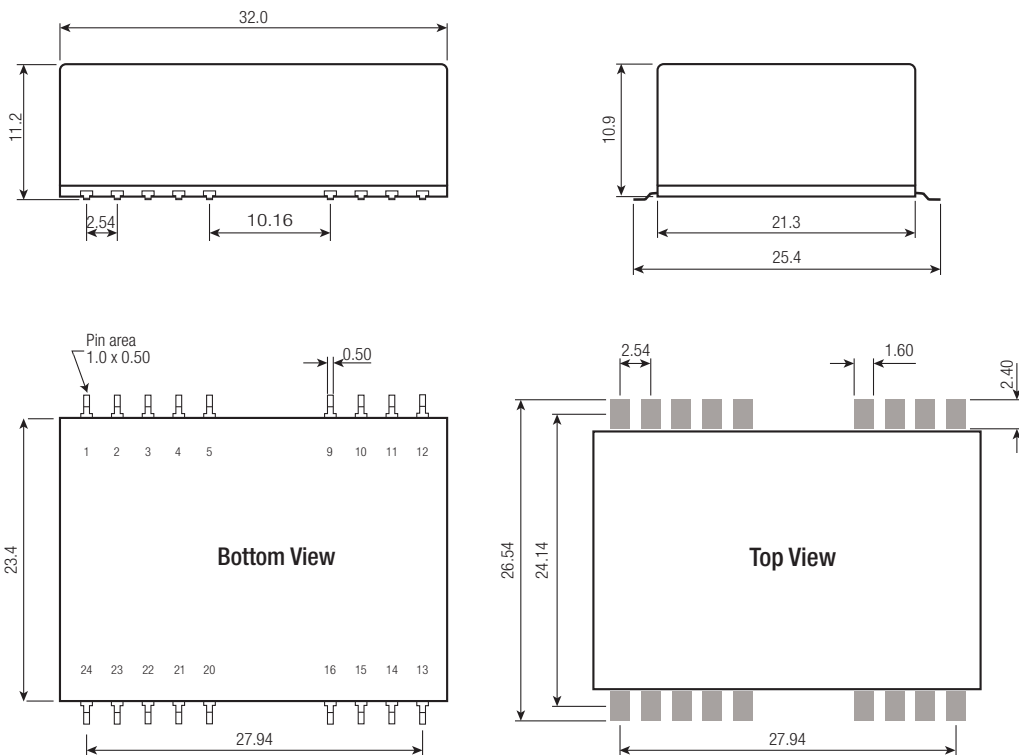

Pin Connections

Pin #	Single	Dual
1	Ctrl	Ctrl
2	-Vin	-Vin
3	-Vin	-Vin
9	NC	Com
11	NC	-Vout
14	+Vout	+Vout
16	-Vout	Com
22	+Vin	+Vin
23	+Vin	+Vin
Others	NC	NC

NC = No Connection
 Pin Pitch Tolerance ±0.25mm
 Pin dimension tolerance ±0.1mm
 XX.X ± 0.5mm
 XX.XX ± 0.25mm

Specifications measured at Ta = 25°C, nominal input voltage, full load otherwise noted

PACKAGING INFORMATION		
Parameter	Type	Value
Packaging Quantity		7 pcs.
Storage Temperature Range		-55°C to +125°C
Storage Humidity		5% - 95% RH